



**Allen Electric  
Connector Sales, Inc.**



### MIL-DTL-5015 Insert Arrangements

Insert arrangements for all MIL-DTL-5015 Series III are the same. The insert arrangements are made by combining the shell size (first two numbers) with the insert arrangement number (last two numbers). For example, a MS3454L14-3P is a shell size 14 with a 3 insert for a 14-3 insert arrangement. Insert arrangements are shown in numerical order by shell size and number of contacts in each shell size.

SHELL SIZE	A	B	C	D	E	F	G	H	I	J	K	L	M	N	O	P	Q	R	S	T	U	V	W	X	Y	Z
14	1.4-3	1.150	1.363	20	1.275	1.50	0.94	2.2	1.316	2.1	NEF															

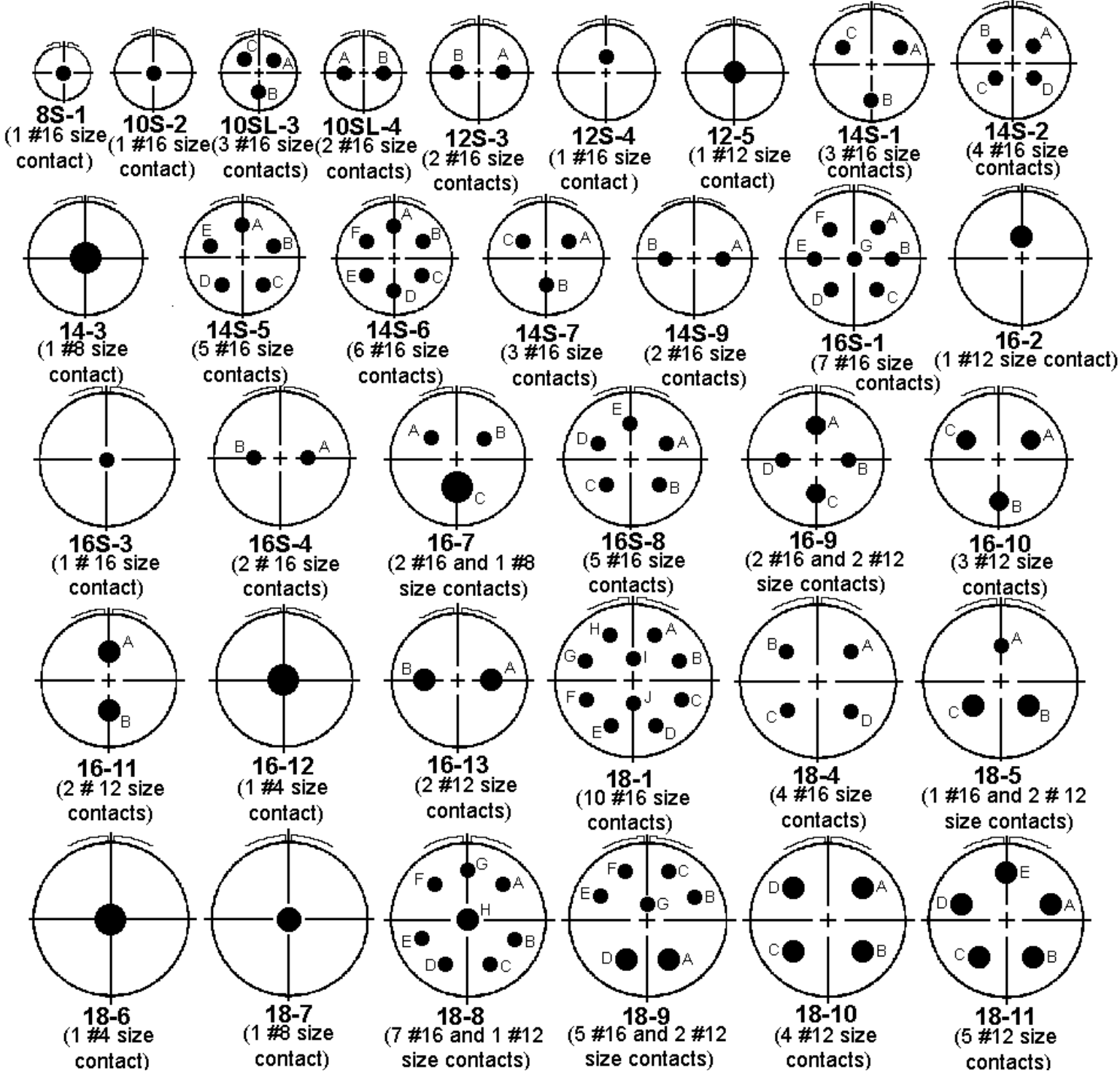

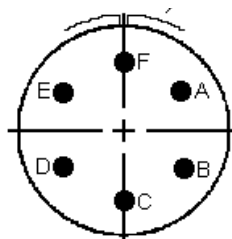

**18-12**  
(6 #16 size contacts)

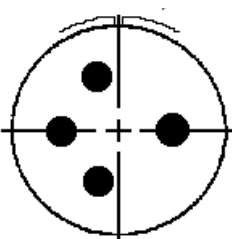

**18-13**  
(3 #12 and 1 #8 size contacts)

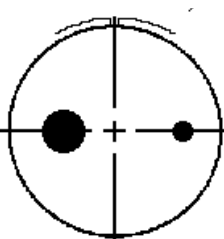

**18-14**  
(1 #16 and 1 #4 size contacts)

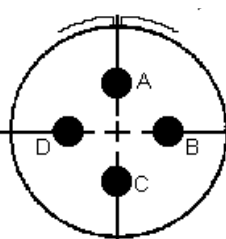

**18-15**  
(4 #12 size contacts)

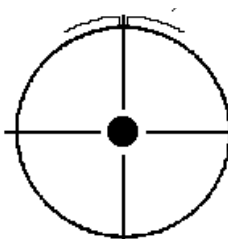

**18-16**  
(1 #12 size contact)

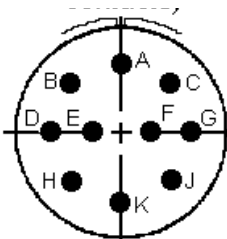

**18-19**  
(10 #16 size contacts)

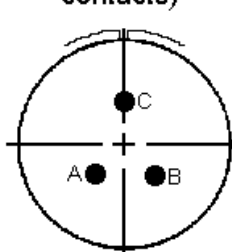

**18-22**  
(3 #16 size contacts)

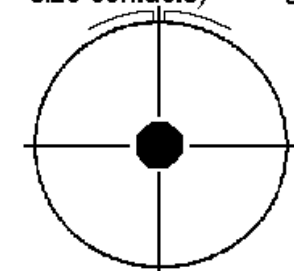

**20-2**  
(1 #0 size contact)

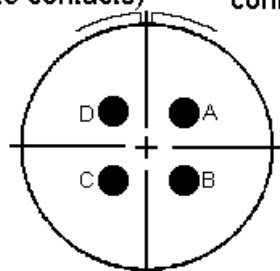

**20-4**  
(4 #12 size contacts)

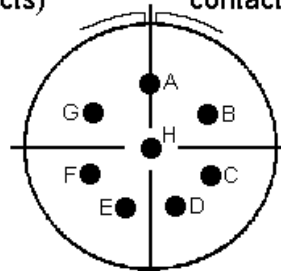

**20-7**  
(8 #16 size contacts)

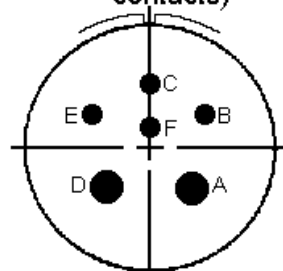

**20-8**  
(4 #16 and 2 #8 size contacts)

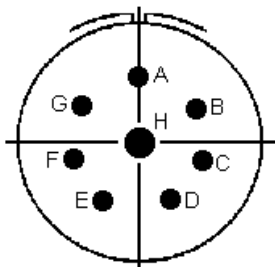

20-9

1 # 12, 7 # 16

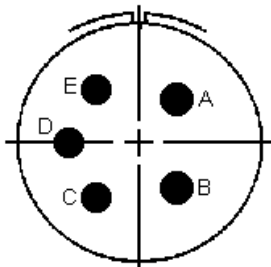

20-14

3 # 12, 2 # 8

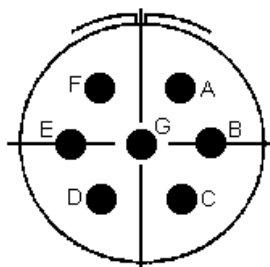

20-15

7 # 12

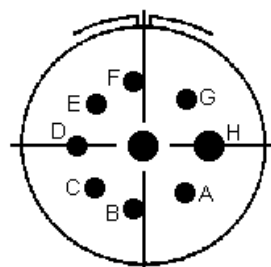

20-16

7 # 16, 2 # 12

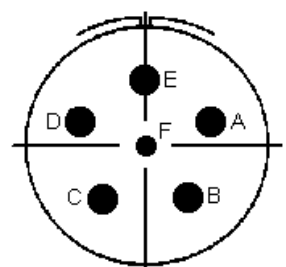

20-17

1 # 16, 5 # 12

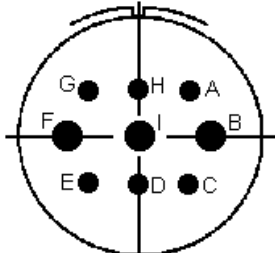

20-18

6 # 16, 3 # 12

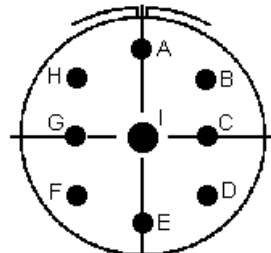

20-21

8 # 16, 1 # 12

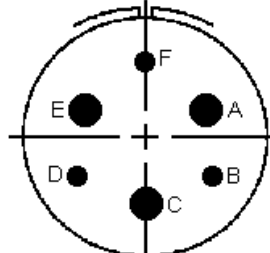

20-22

3 # 16, 3 # 8

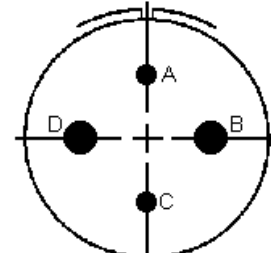

20-24

2 # 16, 2 # 8

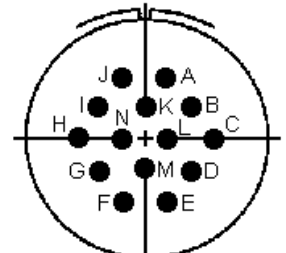

20-27

14 # 16

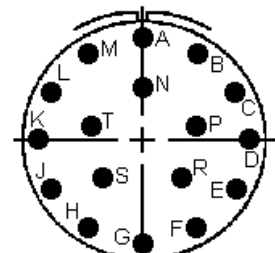

20-29

17 # 16

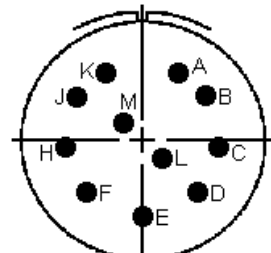

20-33

11 # 16

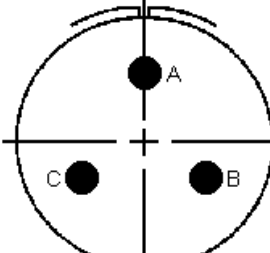

22-2

3 # 8

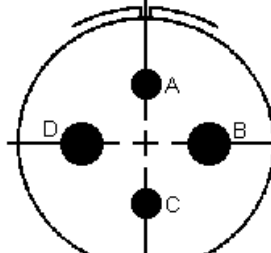

22-4

2 # 12, 2 # 8

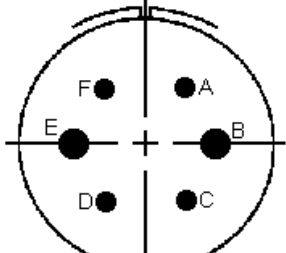

22-5

4 # 16, 2 # 12

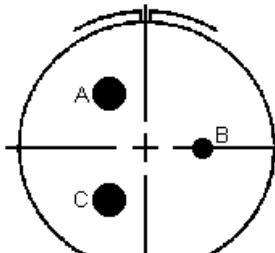

22-6

1 # 16, 2 # 8

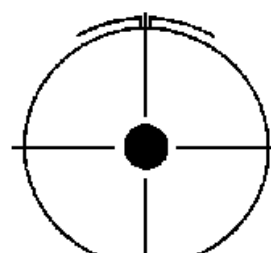

22-7

1 # 0

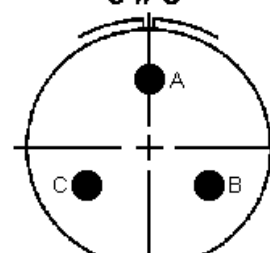

22-9

3 # 12

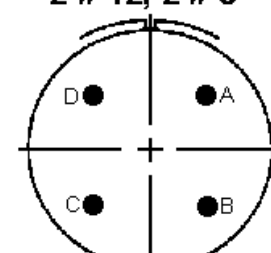

22-10

4 # 16

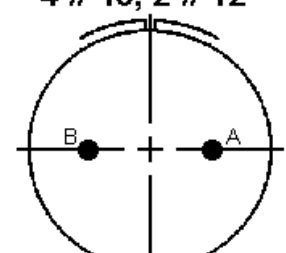

22-11

2 # 16

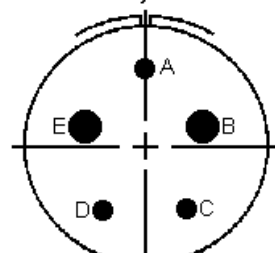

22-12

3 # 16, 2 # 8

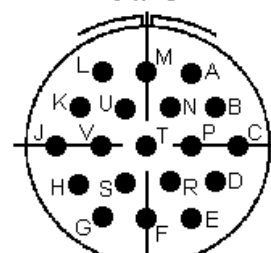

22-14

19 # 16

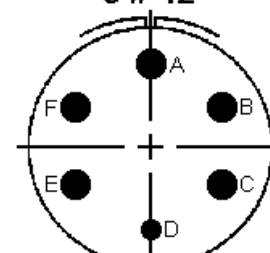

22-15

1 # 16, 5 # 12

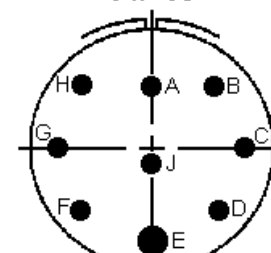

22-17

8 # 16, 1 # 12

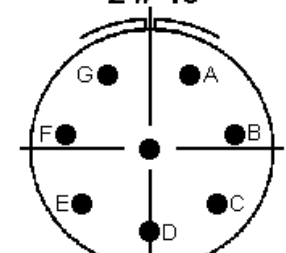

22-18

8 # 16

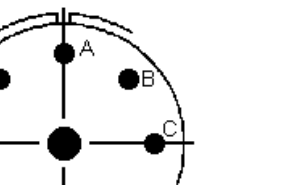
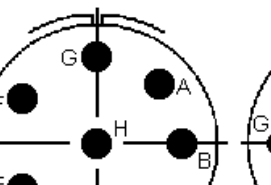
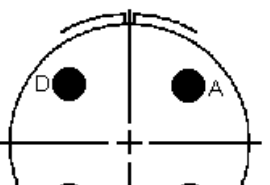
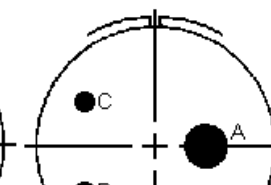
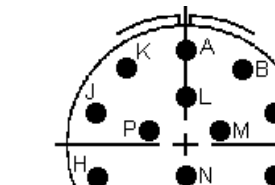



**22-19**  
(14 #16 size contacts)

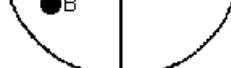

**22-21**  
(2 #16 and 1 #0 size contacts)

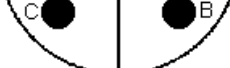

**22-22**  
(4 #8 size contacts)



**22-23**  
(8 #12 size contacts)



**22-27**  
(1 #8 and 8 #16 size contacts)

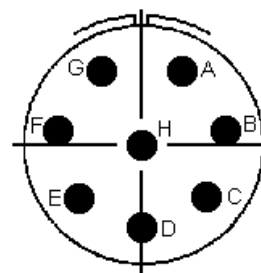

**22-36**  
(8 #12 size contacts)

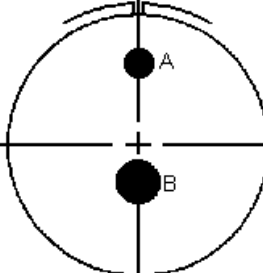

**24-1**  
(1 #12 and 1 #0 size contacts)

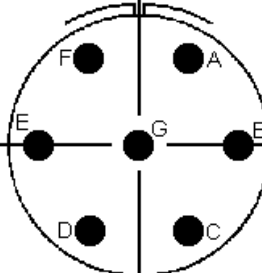

**24-2**  
(7 #12 size contacts)

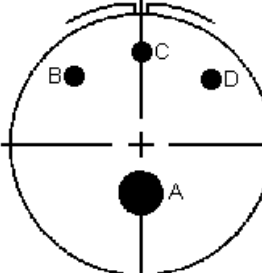

**24-4**  
(3 #16 and 1 #0 size contacts)

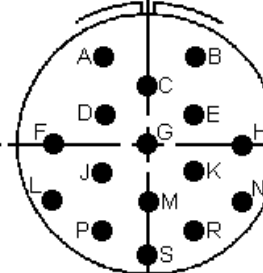

**24-5**  
(16 #16 size contacts)

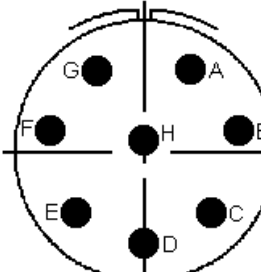

**24-6**  
(8 #12 size contacts)

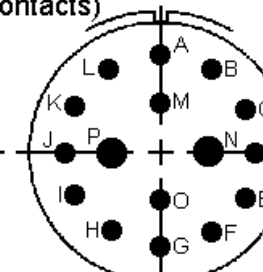

**24-7**  
(14 #16 and 2 #12 size contacts)

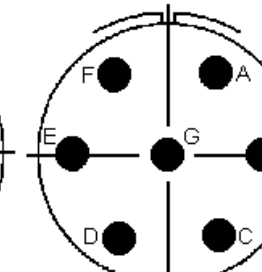

**24-10**  
(7 #8 size contacts)

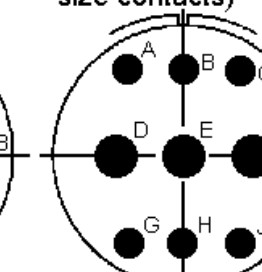

**24-11**  
(6 #12 and 3 #8 size contacts)

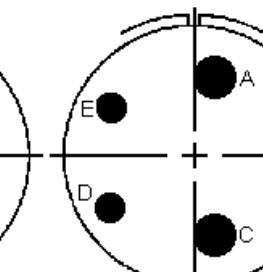

**24-12**  
(3 #12 and 2 #4 size contacts)

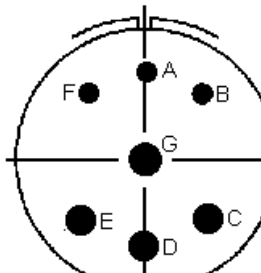

**24-16**  
(3 #16, 1 #8 and 3 #12 size contacts)

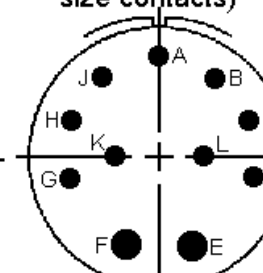

**24-20**  
(9 #16 and 2 #12 size contacts)

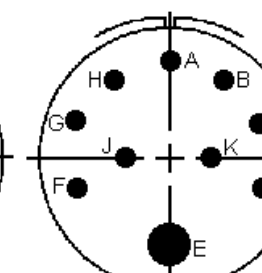

**24-21**  
(9 #16 and 1 #8 size contacts)

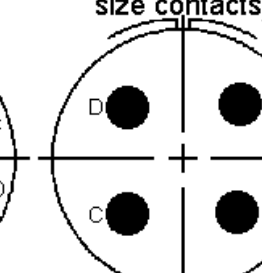

**24-22**  
(4 #8 size contacts)

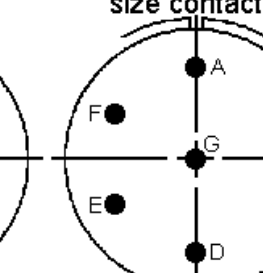

**24-27**  
(7 #16 size contacts)

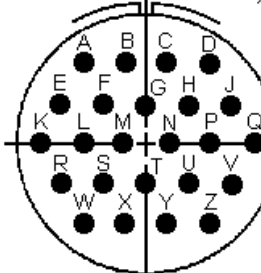

**24-28**  
(24 #16 size contacts)

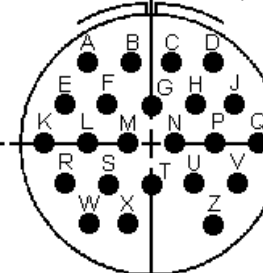

**24-80**  
(23 #16 size contacts)

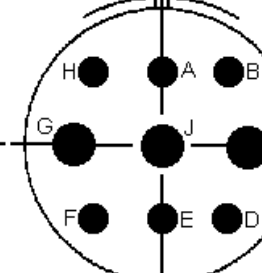

**28-1**  
(6 #12 and 3 #8 size contacts)

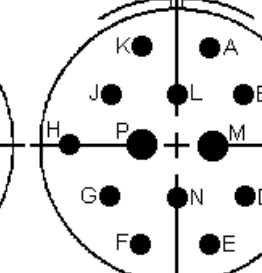

**28-2**  
(12 #16 and 2 #12 size contacts)

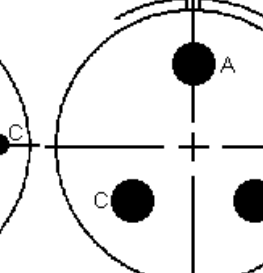

**28-3**  
(3 #8 size contacts)

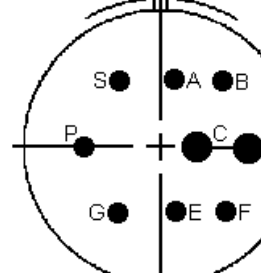

**22-1**

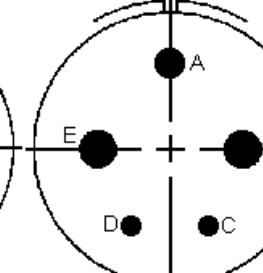

**22-2**

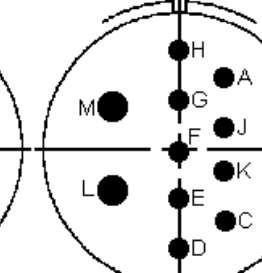

**22-3**

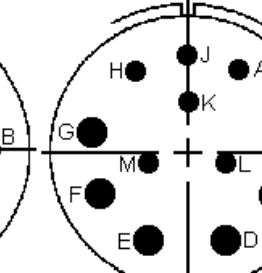

**22-4**

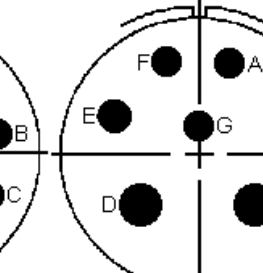

**22-5**

**28-4**  
(7 #16 and 2 #12  
size contacts)

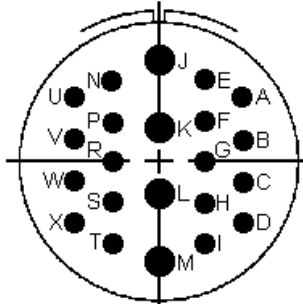

**28-11**  
(18 #16 and 4 #12  
size contacts)

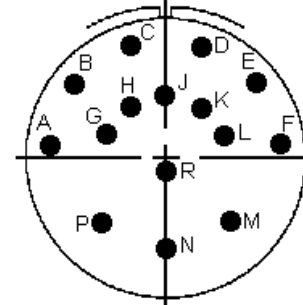

**28-17**  
(15 #16 size  
contacts)

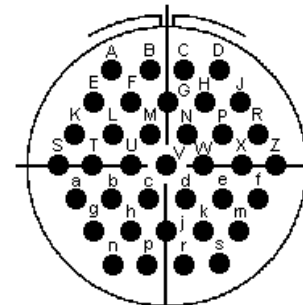

**28-21**  
(37 #16 size  
contacts)

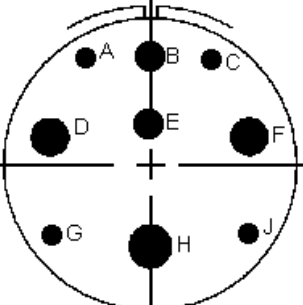

**32-3**  
(4 #16, 2 #12, 2 #4  
and 1 #0 size contacts)

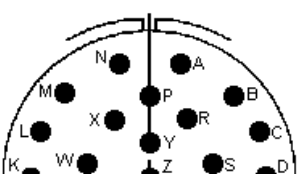

**28-5**  
(2 #16, 1 #12 and  
2 #4 size contacts)

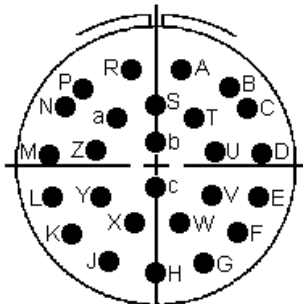

**28-12**  
(26 #16 size  
contacts)

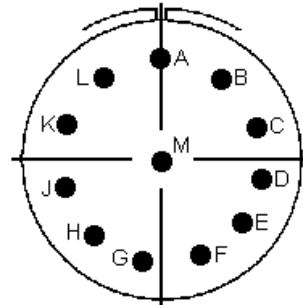

**28-18**  
(12 #16 size  
contacts)

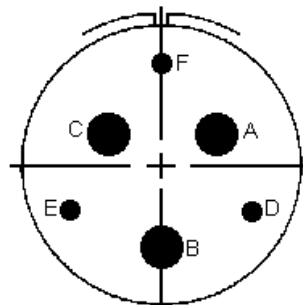

**28-22**  
(3 #16 and 3 #4  
size contacts)

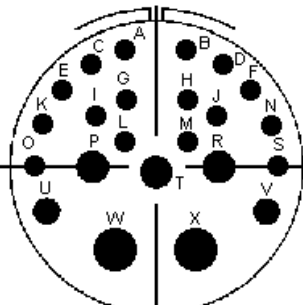

**32-6**  
(16 #16, 2 #12, 3 #8  
and 2 #4 size contacts)

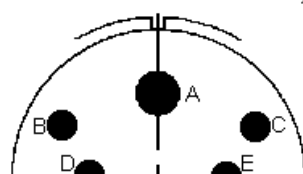

**28-8**  
(2 #12 and 10 #16  
size contacts)

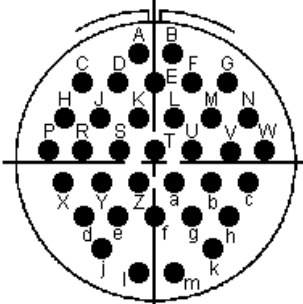

**28-15**  
(35 #16 size  
contacts)

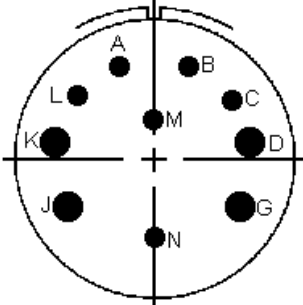

**28-19**  
(6 #16 and 4 #12  
size contacts)

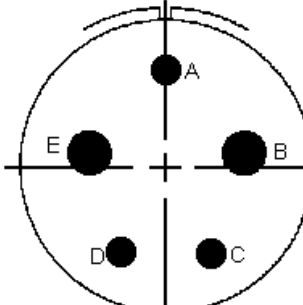

**32-1**  
(3 #12 and 2 #0  
size contacts)

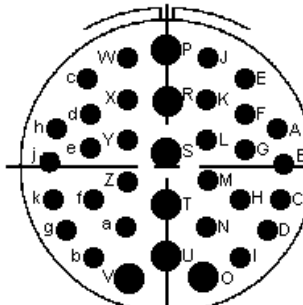

**32-7**  
(28 #16 and 7 #12  
size contacts)

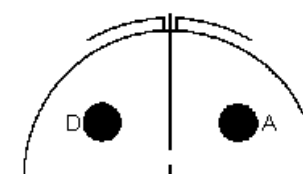

**28-9**  
(6 #16 and 6 #12  
size contacts)

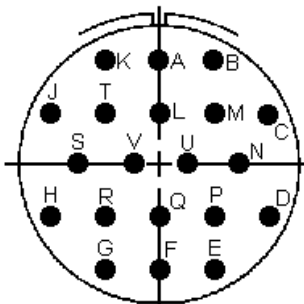

**28-16**  
(20 #16 size  
contacts)

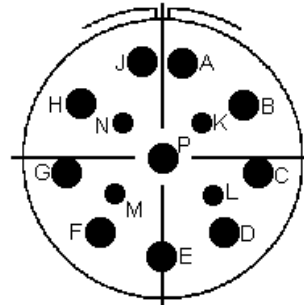

**28-20**  
(4 #16 and 10 #12  
size contacts)

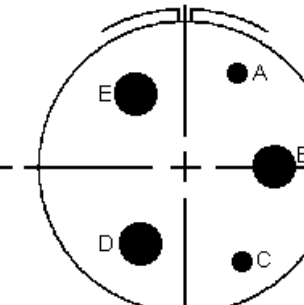

**32-2**  
(2 #16 and 3 #4  
size contacts)

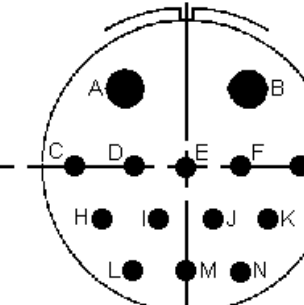

**32-9**  
(12 #16 and 2 #4  
size contacts)



**28-10**  
(3 #12, 2 #8 and  
2 #4 size contacts)

864	120
863	20
115	20
216	20
365	20
486	20
615	17

U	0.02
U	-0.026
120	598
120	585
120	564
20	863
20	115
20	216
20	365
20	486
17	615

U	0.02
U	-0.026
120	598
120	585
120	564
20	863
20	115
20	216
20	365
20	486
17	615

U	0.02
U	-0.026
120	598
120	585
120	564
20	863
20	115
20	216
20	365
20	486
17	615

PANEL CUT



PANEL CUT



PANEL CUT



PANEL CUT



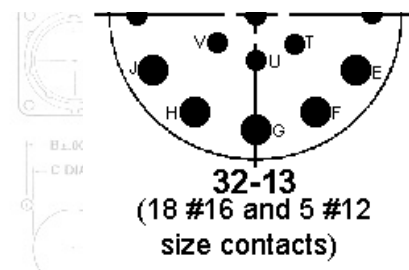

**32-13**  
(18 #16 and 5 #12 size contacts)

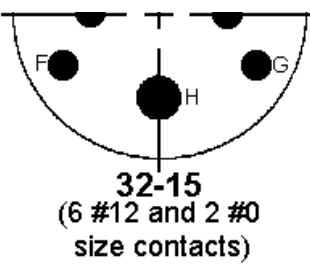

**32-15**  
(6 #12 and 2 #0 size contacts)

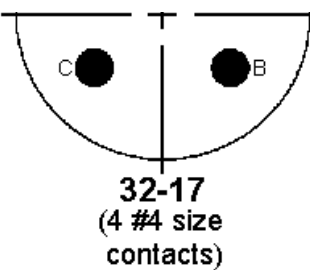

**32-17**  
(4 #4 size contacts)

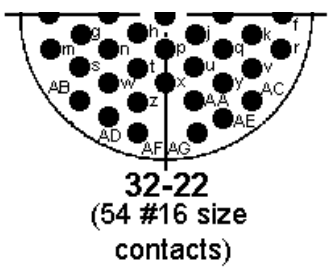

**32-22**  
(54 #16 size contacts)

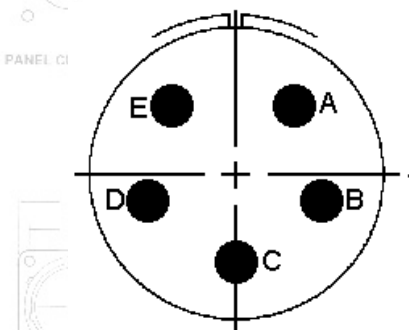

**32-63**  
(5 #4 size contacts)

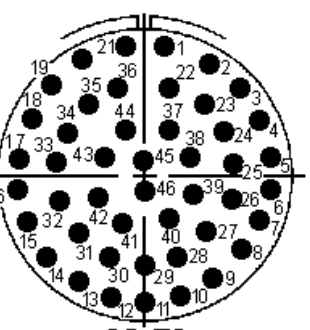

**32-73**  
(46 #16 size contacts)

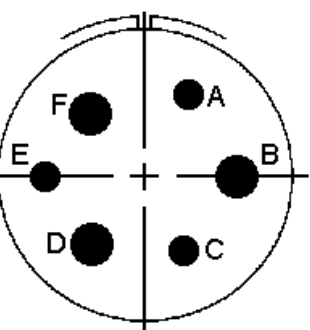

**36-3**  
(3 #12 and 3 #0 size contacts)

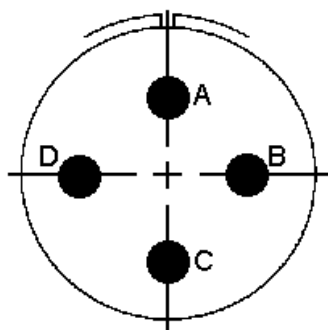

**36-5**  
(4 #0 size contacts)

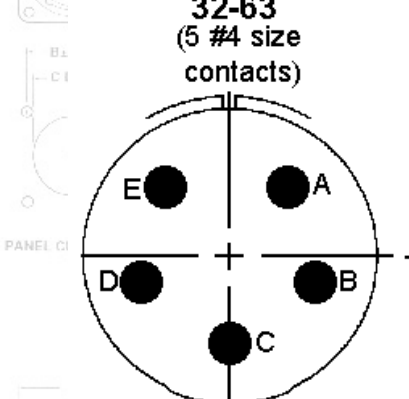

**36-6**  
(4 #4 and 2 #0 size contacts)

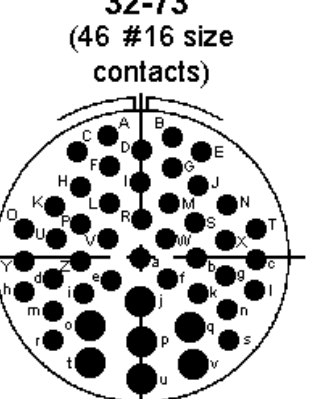

**36-7**  
(40 #16 and 7 #12 size contacts)

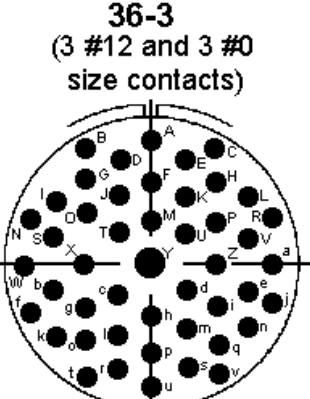

**36-8**  
(46 #16 and 1 #12 size contacts)

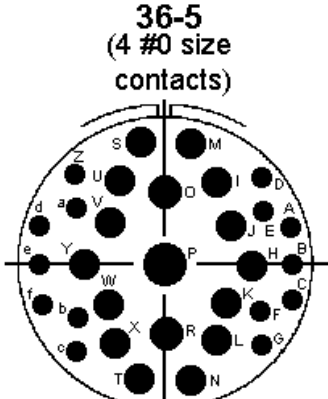

**36-9**  
(14 #16, 14 #12, 2 #8 and 1 #4 size contacts)

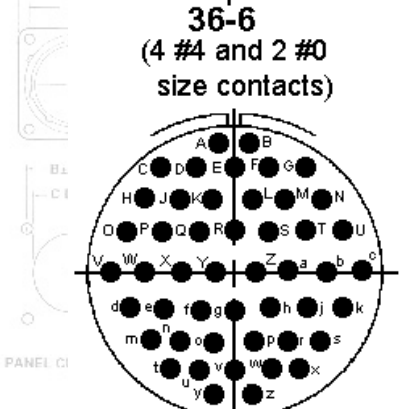

**36-10**  
(48 #16 size contacts)

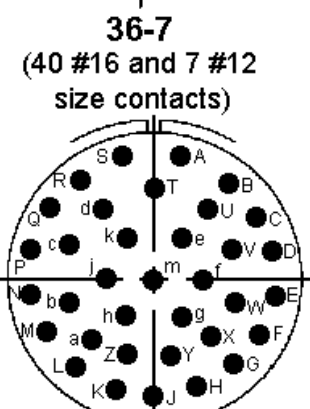

**36-15**  
(35 #16 size contacts)

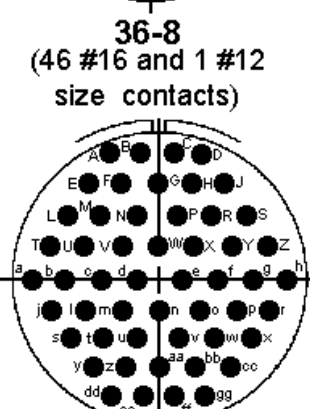

**36-52**  
(52 #16 size contacts)

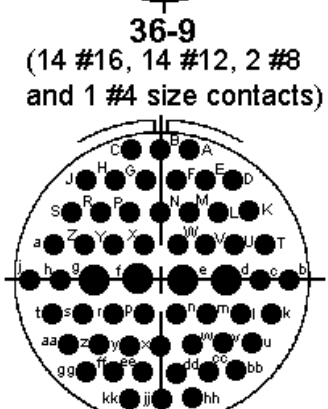

**36-66**  
(52 #16 and 4 #12 size contacts)

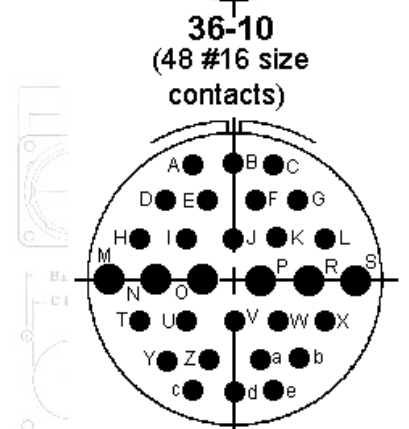

**40-1**  
(24 #16 and 6 #12 size contacts)

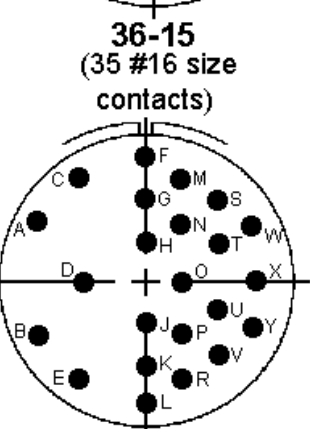

**40-2**  
(23 #16 size contacts)

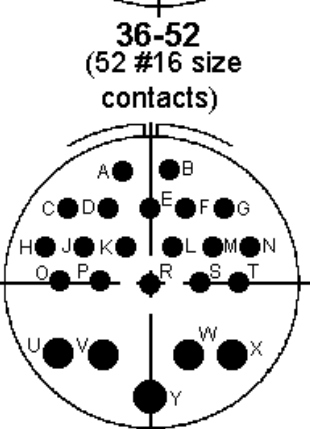

**40-3**  
(18 #16, 4 #12 and 4 #4 size contacts)

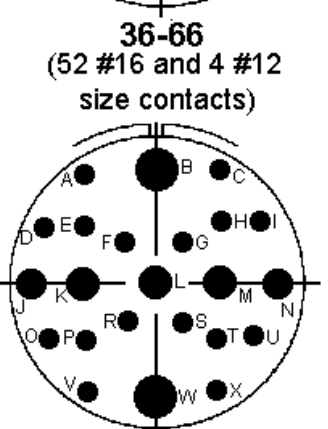

**40-4**  
(16 #16, 2 #12, 3 #8 and 4 #4 size contacts)

U	U
005	-005
598	120
15	120
14	120
19	-20
15	-20
36	-20
65	-20
86	-20
15	-57

U	U
36	-005
18	120
15	120
14	120
19	-20
15	-20
36	-20
65	-20
86	-20
15	-57

U	U
36	-005
18	120
15	120
14	120
19	-20
15	-20
36	-20
65	-20
86	-20
15	-57

U	U
36	-005
18	120
15	120
14	120
19	-20
15	-20
36	-20

size contacts)

contacts)

1 #4 size contacts)

2 #4 size contacts)

65	20
85	20
15	67

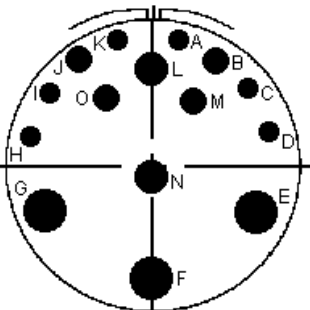

**40-5**  
(5 #12, 4 #8 and 3 #0 size contacts)

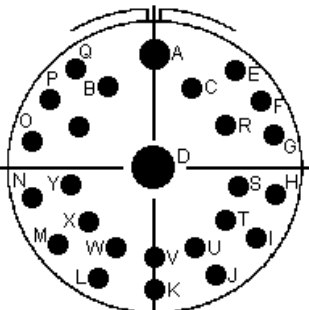

**40-6**  
(24 #16, 1 #12 and 1 #0 size contacts)

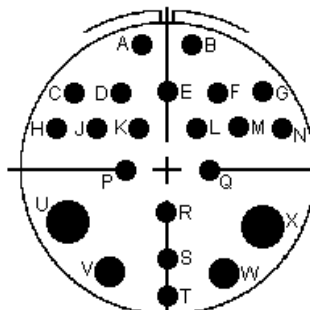

**40-7**  
(2 #12, 2 #0 and 18 #16 size contacts)

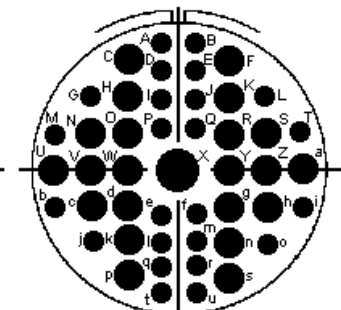

**40-9**  
(24 #16, 22 #12 and 1 #8 size contacts)

	U
05	005
18	120
15	120
15	120
19	20
15	20
16	20
65	20
85	20
15	67

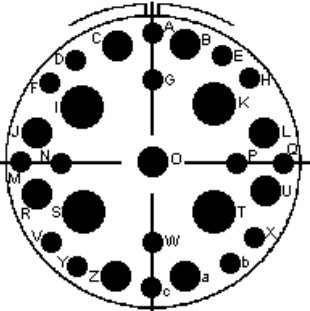

**40-10**  
(16 #16, 9 #8 and 4 #4 size contacts)

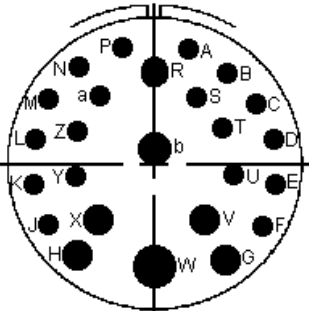

**40-11**  
(18 #16, 4 #12, 1 #8, 1 #4 and 1 #0 size contacts)

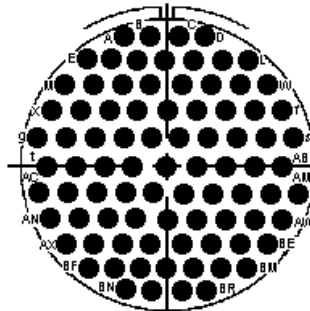

**40-56**  
(85 #16 size contacts)

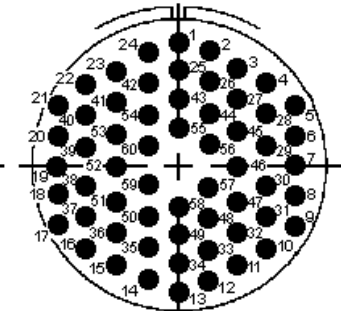

**40-62**  
(60 #16 size contacts)

For pricing and availability, please fill out our RFQ form



If you need any other information, please E-Mail [aecs@aecsinc.com](mailto:aecs@aecsinc.com)



phone (703) 425-3815 fax (703) 425-3814

We look forward to hearing from you!



SHELL SIZE	A MAX	B ±.005	C ±.035	D ±.035	E MAX	F ±.015	G ±.010	H MAX	J
8	828	554	568	120	1275	446	652	687	1/2-20 UNF
10	954	719	585	120	1275	446	652	687	3/8-24 UNF
12	1047	812	585	120	1275	446	652	687	3/8-24 UNF
14	1131	906	585	120	1275	446	652	687	3/8-24 UNF
16	1234	986	1115	20	1215	486	687	687	1-20 UNEF
18	1338	1067	1236	20	1215	486	687	687	1-16-18 UNF
20	1443	1150	1365	20	1275	527	684	712	1-16-18 UNF
22	1578	1250	1485	20	1275	527	684	712	1-16-18 UNF

SHELL SIZE	A MAX	B ±.005	C ±.035	D ±.035
8	828	554	568	120
10	954	719	585	120
12	1047	812	584	120
14	1131	906	583	20
16	1234	986	1115	20
18	1338	1067	1236	20
20	1443	1150	1365	20
22	1578	1250	1486	20

A Woman Owned Small Business, CAGE Code 07BG6